

heatilator[®]
The first name in fireplaces



Rave

direct vent gas fireplace

Rave direct vent gas fireplace

The best-valued landscape fireplace in the industry.

- The Rave provides a modern, landscape option that is value priced to fit in any floorplan
- Looks great as is, or upgrade with media options
- 26,000 Btu/Hour Input for comfortable heat output
- Direct vent system uses only outside air for combustion and vents outside for better indoor air quality and a healthy home
- Top direct-vent system only
- WSK-21 wall control included
- Utilizes SLP venting components
- Tested and listed to ANSI standards
- Limited Lifetime Warranty**



Above: Rave shown with Deco front in Black
Cover: Rave shown with Illusion front in Black

Front Options

Deco Front
Clean, modern front with protective mesh. Shown in Black; also available in Bronze



Illusion front
Clean, modern front with convex face and protective mesh. Shown in Black; also available in Bronze



Front Finishes

Two rich finishes. High on style, long on durability Available on both fronts



Black

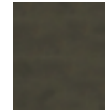

Bronze

Media

Accent the firebox with glass. Two cool colors to warm up your flame

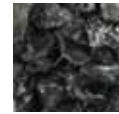

Black Glass



Crystal Glass

Dimensions

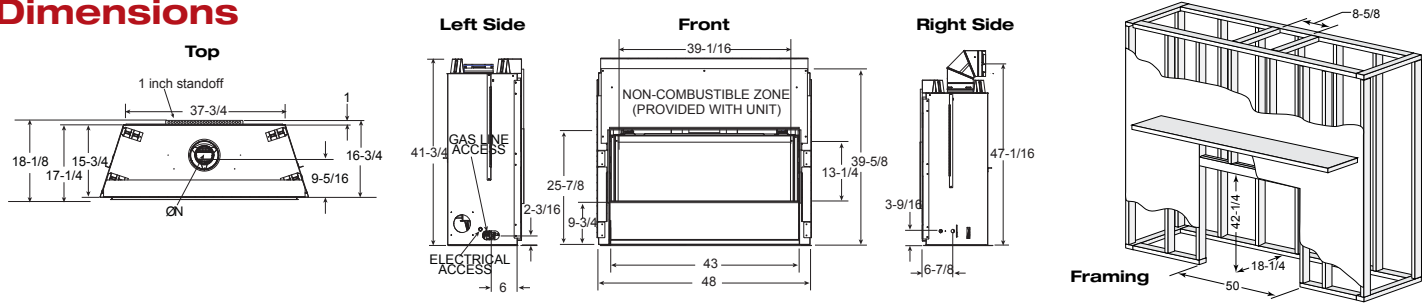

U.S. Efficiencies

Steady State - Since most homeowners use their fireplaces for an extended time while they are in the room, Steady State measures how efficiently your fireplace converts fuel to heat once it is warmed up and running in a "steady state".

AFUE - AFUE rating is more typically used with appliances, like your furnace, that continually cycle on and off to maintain a constant temperature.

Rating	RAVE4013I
Steady State	75.3% (NG) 75.3% (LP)
AFUE	59.5% (NG) 64.4% (LP)

Canada Efficiencies

EnerGuide (CSA P.4.1-02) - EnerGuide is a rating used in Canada to measure annual fireplace efficiency.

Rating	RAVE4013I
EnerGuide (CSA P.4.1-02)	60.6% (NG) 63.4% (LP)

Available From

heatilator
The first name in fireplaces

A brand of Hearth & Home Technologies Inc.
1915 W. Saunders Street, Mt. Pleasant, IA 52641
Web: heatilator.com
Phone: (800) 927-6481

The information provided in this literature is for planning purposes only and subject to change. Please consult the installation manual for actual installation. Actual product appearance may differ from product images.
*For full warranty details go to heatilator.com.

Limited Lifetime Warranty*

The strongest in the industry, Heatilator provides a limited lifetime warranty on the most important aspects: firebox and heat exchanger.

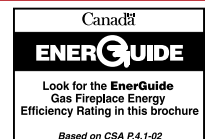

HTL-1064U-1009